



The safer, faster and more accurate way to cut flexographic plates

With the Flexo Plate Cutter, you can accurately pre-cut flexo on the flat.

By using the sightline strip you can precisely align to your target marks for the first and second cut – there is no need to cut flexo on the round. There is less chance of costly mistakes, which often result in production downtime and the need to re-schedule work. You will quickly create seamless splices every time and save both time and money.

The cutter is also intuitive to use and with a little training and practice, precise flexo cutting is achievable by all operators.

The dual cutter head gives the option of creating a bevelled overlapping joint, or alternatively a 5° undercut, so both plate edges meet perfectly when applied to the roller. The perfect joint prevents ink traps or any deterioration of the adhesive.

The Flexo Plate Cutter is specially designed to ensure your safety and increase production.

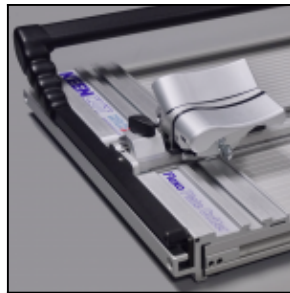
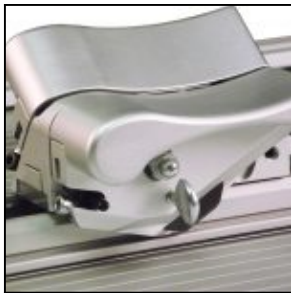

Materials cut

Designed specifically to cut flexographic plates.

Also capable of cutting:

Floor graphics

Vinyl

Rubber matting

Corrugated cardboard

Foam centred board



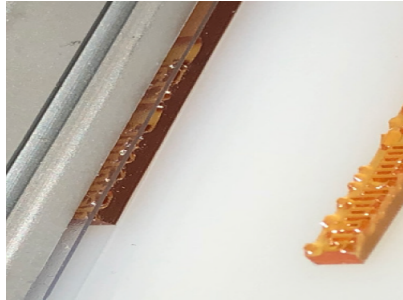

Perfect accuracy for tight joins

The design gives a lifetime of straight, precision accurate, silent cutting. The cutting head features a set of built-in self-aligning ball bearing rollers operating on twin steel tracks. There is zero play on the cutting head sliding action and the base is constructed of a heavy-duty, one-piece aluminium extrusion for complete stability. The precision accuracy produces seamless splices and eliminates costly mistakes, whilst the 5-degree undercut creates a tight join when the flexo is attached to the cylinder.

Bevel & 5° undercut cutting head

The spring-loaded bevel and 5° undercut blade holder features ball and thrust bearings for perfect alignment and superb blade control. The cutting head is mounted on two stainless steel tracks and hardened steel ball track rollers. All combined, they work together to give the ultimate in blade control.

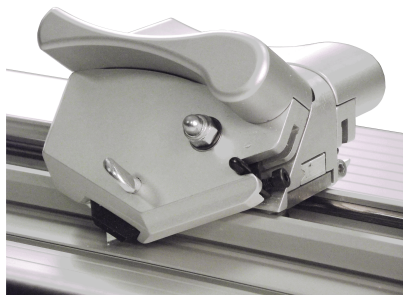

Safety by design

The Flexo Plate Cutter ensures your safety and removes the dangerous practice of cutting flexo by hand with a knife. Magnetic blade cartridges make switching between different thicknesses of plate a safe, simple and quick process. Everything has been designed to ensure your safety.

Simple operation

You can have various blade depths pre-set within different cartridges, so a precise and repeatable cut can be made by simply switching to a new cartridge.

You can be confident of getting the right cut first time, every time and eliminating variability. The maximum blade depth for the bevel blade is 5mm (3/16"), the 5° undercut blade fitted with a trapezoidal blade is 10mm (3/8") and a rectangular blade is 8mm (5/16"). Simple colour coding makes it easy to identify and calibrate the pre-set depths.



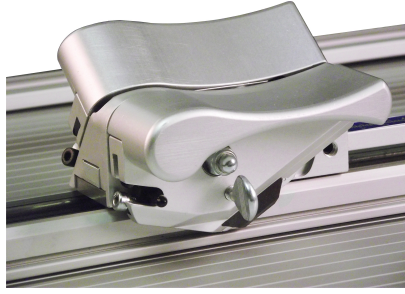

Ergonomically designed cutting head

The sculpted cutting head makes the Flexo Plate Cutter easy to use over long periods and is suitable for operation by left or right-handed users. A smooth sliding action provides precise cutting with no discernible friction.

Five year guarantee

By manufacturing in-house, with only the highest quality materials, Keencut can guarantee that the Flexo Plate Cutter will provide reliable long-lasting and accurate service. All Keencut products are offered with a comprehensive five year guarantee. [Register your product to activate your guarantee >](#)



In the box

- 15 Tech-S .015 blades
- 15 Tech-S .012 blades
- 15 Tech-D .012 blades
- 100 medium duty utility blades



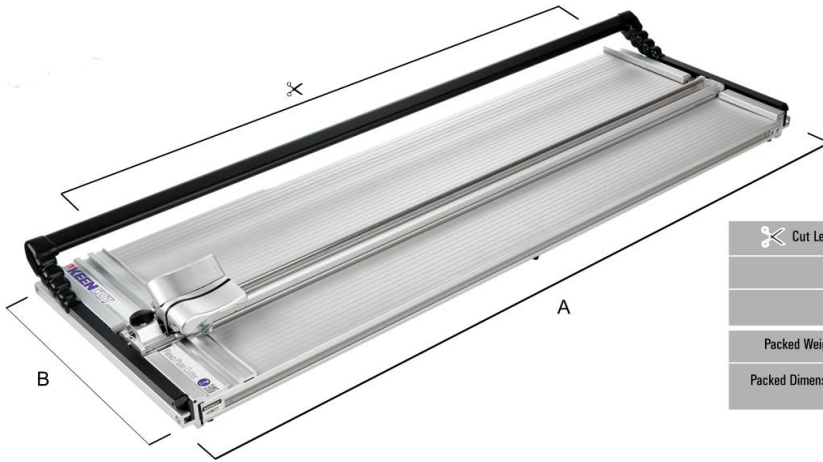

	FPC18	FPC32	FPC50	FPC64	FPC84
 Cut Length cm (")	46 (18)	81 (32)	127 (50)	163 (64)	214 (84)
A cm (")	70 (27.5)	105 (41)	151 (59.5)	187 (73.5)	240 (94.25)
B cm (")	39 (15.5)	39 (15.5)	39 (15.5)	39 (15.5)	39 (15.5)
Packed Weight KG (lbs)	10.5 (23)	13.5 (30)	18 (40)	37 (81.5)	46.5 (102.5)
Packed Dimensions cm (")	75x42x17 (30x17x7)	110x42x17 (43x17x7)	156x42x17 (61x17x7)	200x45x17 (79x18x7)	251x45x17 (99x18x7)

